



Status

<input type="checkbox"/> Aanvraag	<input type="checkbox"/> Bestelling
<input type="checkbox"/> Zicht	

Datum

--

Gegevens Dealer

Dealer	
Adres	
Pc/ Woonplaats	
Contactpersoon	
E-mail	
Tel	
Fax	

Afleveradres

Dealer	
Adres	
Pc/ Woonplaats	
Contactpersoon	

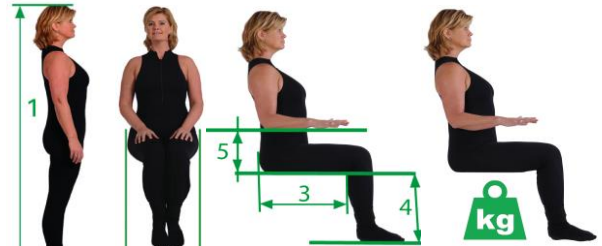

Max. 120 kg

Gegevens gebruiker

Voor- en achternaam	
Leeftijd	
Gewicht	
1) Lichaamslengte staand - cm	
2) Heupbreedte zittend - cm	
3) Bovenbeenlengte - cm	
4) Onderbeenlengte - cm	
5) Ellebooghoogte - cm	

Belangrijk volledig invullen!

Gewenste instelling

Zithoogte voor (F) - cm		Standaard = 51
Zithoogte achter (G) - cm		Standaard = 49
Wielbalans / Zwaartepunt (W) - cm		Standaard = 7

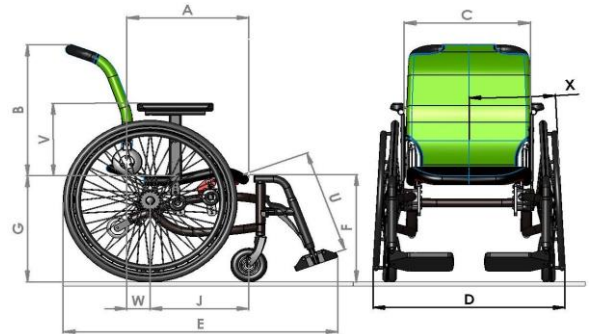

Basisprijs

€

2.610

Alle prijzen excl. Btw.

Gegevens van de rolstoel

Aanpassingen



Meerprijs opties	€
Meerprijs aanpassingen	€
Totale verkoopprijs	€
Verpakkings- en transportkosten	€ 45,-

Onze algemene leverings- en verkoopvoorwaarden zijn te downloaden via www.o4.eu Technische wijzigingen en drukfouten voorbehouden.

O4 Wheelchairs Markenweg 9, 7051 HS Varsseveld, Nederland T: +31 (0) 315 396 900 F: +31 (0) 315 396 909 E: info@o4.eu I: www.rolstoel.nl

Zitbreedte (C)

<input type="checkbox"/> 34cm	<input type="checkbox"/> 36,5cm	<input type="checkbox"/> 39cm	<input type="checkbox"/> 41,5cm	<input type="checkbox"/> 44cm	<input type="checkbox"/> 46,5cm	<input type="checkbox"/> 49cm	<input type="checkbox"/> 51,5cm
Standaard	Standaard	Standaard	Standaard	Standaard	Op aanvraag	Op aanvraag	Op aanvraag
Art : 800-40134	Art : 800-40136	Art : 800-40139	Art : 800-40141	Art : 800-40144	Art : 800-40146	Art : 800-40149	Art : 800-40151

Framelengte (J)

<input type="checkbox"/> 31cm	<input type="checkbox"/> 34cm	<input type="checkbox"/> 40cm
Aanbevolen zitdiepte 37,5 - 42,5cm	Aanbevolen zitdiepte 40 - 45cm	Aanbevolen zitdiepte 42,5 - 50cm
Art : 800-40034	Art : 800-40040	Art : 800-40045

Taxifixatie

<input type="checkbox"/>
€ 292 4 aan het frame gelaste bevestigingspunten. Geschikt voor het vastzetbaar vervoeren van de rolstoel middels 4-puntsbandensysteem, volgens Code VVR, type B.
Art : 200-20021





Framekleur

<input type="checkbox"/> Antraciet	<input type="checkbox"/> Wit RAL 9016	<input type="checkbox"/> Blauw RAL 5002	<input type="checkbox"/> Zwart RAL 9005	<input type="checkbox"/> Rood RAL 3003	<input type="checkbox"/> Speciaal - Uni	<input type="checkbox"/> Speciaal - Metallic
Standaard	Standaard	Standaard	Standaard	Standaard	€ 90	Op aanvraag
					Gewenste RAL-kleur aangeven via www.ralkleuren.com	
Art : 800-40310	Art : 800-40330	Art : 800-40335	Art : 800-40340	Art : 800-40345	Art : 800-40350	Art : 800-40300

Camberhoek (X)

<input type="checkbox"/> 0°	<input type="checkbox"/> 3°	<input type="checkbox"/> 6°	<input type="checkbox"/> 9°
Standaard	Standaard	€ 100	€ 172
Art : 800-40400	Art : 800-40403	Art : 800-40406	Art : 800-40409

Voetsteun (U)

<input type="checkbox"/> 	<input type="checkbox"/> 	<input type="checkbox"/> 	<input type="checkbox"/> 
Opklapbaar 2 delig	Opklapbaar 1 delig	Comfort-beensteun	
Beensteunen, onderbeenlengte instelbaar, afneembaar, wegzwenkbaar met hoekverstelbare voetplaten	Beensteunen, onderbeenlengte instelbaar, afneembaar, wegzwenkbaar met hoekverstelbare voetplaten	Beensteun, onderbeenlengte instelbaar, afneembaar, wegzwenkbaar met hoekverstelbare voetplaat	
Standaard	€ 227	€ 195	€ 195
Art : 800 - 30000	Art : 800 - 30600	Art : 800-31010	Art : 800-31020

Voetplaat (alleen in combinatie met voetsteun hoogklapbaar 1-delig)

<input type="checkbox"/> 	<input type="checkbox"/> 	<input type="checkbox"/> 	<input type="checkbox"/> Maatwerk	<input type="checkbox"/> Maatwerk
Standaard (23 x 12 cm) Aluminium	Breed (29 x 12cm) Aluminium	Diep (23 x 19cm) Aluminium	Aluminium	Kunststof
Vanaf zitbreedte 39cm	Vanaf zitbreedte 44cm	Vanaf zitbreedte 39cm	in opdracht na tekening	
Standaard	€ 68	€ 68	Op aanvraag	
Art : 800 - 38009	Art : 800 - 38010	Art : 800 - 38040	Art : 800 - 3801 x	Art : 800 - 3802 x

Zitdiepte (A)

<input type="checkbox"/> 35cm	<input type="checkbox"/> 37,5cm	<input type="checkbox"/> 40cm	<input type="checkbox"/> 42,5cm	<input type="checkbox"/> 45cm	<input type="checkbox"/> 47,5cm	<input type="checkbox"/> 50cm
Alleen met RCA 1.5						Niet met RCA1.5
Art : 800-40535	Art : 800-40537	Art : 800-40540	Art : 800-40542	Art : 800-40545	Art : 800-40547	Art : 800-40550

Zitting

<input type="checkbox"/>	<input type="checkbox"/>	<input type="checkbox"/>	<input type="checkbox"/>
			
Zitting vlak, bespannen, Cordura, voor inlegkussen	Zitting vlak, aluminium, voor inlegkussen	Zitting vlak met Seat-E-Lastica; niet in combinatie met RCA 1.0	Zitting contour ergonomisch, gestoffeerd
Standaard	€ 527	€ 290	€ 490
Art : 100-140 x x	Art : 100-143 x x	Art : 100-142 x x	Art : 100-122 x x

Zitkussen

<input type="checkbox"/>	<input type="checkbox"/>	<input type="checkbox"/>
		Maatwerk
Zitkussen hard	Zitkussen zacht	In opdracht na tekening
5cm vlokenschuim	3 cm latex boven 2 cm vlokenschuim onder	
€ 94	€ 159	Op aanvraag
Art : 100-412 x x	Art : 100-411 x x	Art : 100-413 x x





Rugversteller

<input type="checkbox"/>	<input type="checkbox"/>	<input type="checkbox"/>
		
Basis	RCA 1.0	RCA 1.5
Rug neerklapbaar en rughoek mechanisch instelbaar.	Rugversteller gecentreerd.	Rugversteller 2,5 cm teruggezet
(Verstelbereik 85° - 115°)	Permanent verstelbaar door gebruiker in stappen van 3° (Verstelbereik 0 - 85 - 115°) RCA = Remote Continuous Adjustable	
Standaard	€ 475	€ 545
Art : 100-38000	Art : 100-32000	Art : 100-36000

<input type="checkbox"/>

Versterking RCA 1.0 (Spasme)
Rugversteller gecentreerd.
Prijs op aanvraag
Art : 100-32500



Rugvorm

<input type="checkbox"/>	<input type="checkbox"/>	<input type="checkbox"/>	<input type="checkbox"/>
			
Vorm recht	Ergonomisch, anatomisch vanaf rughoogte 40cm	Rugleuning voor vrouwen, ergonomisch, anatomisch vanaf rughoogte 40cm	Deltarugleuning, enkel bij zitbreedte 39cm, 41,5cm en 44cm. Verkrijgbaar in 2 hoogten: 60cm / 70cm
Standaard	€ 393	€ 495	€ 495
Art : 100-225 x x	Art : 100-200 x x	Art : 100-220 x x	Art : 100 - 240 x x







Rughoogte (B)

<input type="checkbox"/>	<input type="checkbox"/>	<input type="checkbox"/>	<input type="checkbox"/>
			
Hoogte 35cm	Hoogte 40cm	Hoogte 45cm	Hoogte 50cm
Art : 800-42135	Art : 800-42140	Art : 800-42145	Art : 800-42150

Deltarughoogte

<input type="checkbox"/>	<input type="checkbox"/>
	
Hoogte 60cm	Hoogte 70cm
Art : 800-42160D	Art : 800-42170D

Kleur rughoes



<input type="checkbox"/>	<input type="checkbox"/>	<input type="checkbox"/>	<input type="checkbox"/>	<input type="checkbox"/>	<input type="checkbox"/>	<input type="checkbox"/>	<input type="checkbox"/>
							Reservehoes rugleuning
Oranje	Rood	Zwart	Donkerblauw	Zilvergrijs	Geel	Blauwgroen	Kleur:
Standaard	Standaard	Standaard	Standaard	Standaard	Standaard	Standaard	€ 91
Art : 100-400 x x	Art : 100-401 x x	Art : 100-402 x x	Art : 100-405 x x	Art : 100-406 x x	Art : 100-407 x x	Art : 100-408 x x	Art : 100-40x x x

Wieldiameter

Mogelijke zithoogte zie maatblad

<input type="checkbox"/> 22" x 1 - (25 - 489)	<input type="checkbox"/> 24" x 1 - (25 - 540)
€ 76	Standaard
Marathon Plus Evolution banden	
Alleen in combinatie met 4 inch voorwielen	
Art: 800-41022	Art: 800-41024

Aandrijf wiel (set, met Quick Release)

Set <input type="checkbox"/>	Set <input type="checkbox"/>	Set <input type="checkbox"/>
		
	Trommelrem (set) Incl. Frame-aanpassing. Standaard met zwarte aluminium hoepels, alleen in 24" leverbaar. Duwbeugel sterk aanbevolen	Wielset versterkt
Standaard	€ 1.029	€ 375
Art : 800-41024	Art : 991 - 42 x x x	Art : 991 - 2 X 202

Sportief

<input type="checkbox"/>	<input type="checkbox"/>	<input type="checkbox"/>
Lichtgewicht Spinergy-wielen	Tensio lichtgewicht wielen	Tensio Heavy Duty wielen
Set	Set	Set
Op aanvraag	Op aanvraag	Op aanvraag
Art : 991 - 43 x x x	Art : 991 - 455 0 x	Art : 991 - 455 1 x

Éénhandaandrijving

Aandrijving Links <input type="checkbox"/>		Aandrijving Rechts <input type="checkbox"/>
Éénhandaandrijving (Hemi) Wielset, incl frameaanpassing. - Minimale zithoogte 2 cm hoger (voor en achter) - Niet mogelijk met 6° - 9° camber. Alleen in 24"		
€ 1.363		
Art : 991 - 41 x x x		

Achterband





<input type="checkbox"/>	<input type="checkbox"/>	<input type="checkbox"/>	<input type="checkbox"/>	<input type="checkbox"/>
				
Schwalbe Marathon Plus Evolution	Massief - PU	Schwalbe Right Run Rood	Schwalbe Right Run Blauw	Schwalbe Right Run Grijs
Standaard	€ 85	€ 0	€ 0	€ 0
Art : 991-67 x 01	Art : 991-67 x 11	Art : 991-67 X 21	Art : 991-67 X 22	Art : 991-67 X 23

Elektrische wielnaaf aandrijving / ondersteuning (Alber)

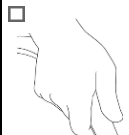
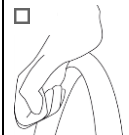
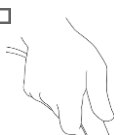

Alber-aandrijving is technisch mogelijk, aanbevolen frame aanpassing - € 104

Levering wielset via dealer





Hoepel (paar)

<input type="checkbox"/>	<input type="checkbox"/>	<input type="checkbox"/>	<input type="checkbox"/>	<input type="checkbox"/>	Links <input type="checkbox"/>	Rechts <input type="checkbox"/>	Hoepelafstand	
							<input type="checkbox"/>	<input type="checkbox"/>
Aluminium	TETRA	PARA	ERGO	Roestvrijstaal	Hoepel-overtrek (1 Stuk)	Hoepel-overtrek (1 Stuk)	Smal	Breed
	Gripversterkende hoepels	Gripversterkende hoepels	Gripversterkende hoepels					
Standaard	€ 430	€ 430	€ 468	€ 245	€ 95,00	€ 95,00	Standaard	Zonder meerprijs
Art : 800-62x11	Art : 800-62x01	Art : 800-62x02	Art : 800-62x03	Art : 800-62x12	Art : 991-61x01	Art : 991-61x01	-	-

Wiel accessoire (paar)



<input type="checkbox"/>		<input type="checkbox"/>	
Spaakbeschermer transparant		Spaakbeschermer transparant met O4-opdruk	
€ 120		€ 100	
Art : 991 - 60 x 01		Art : 991 - 60 x 02	





Rem





<input type="checkbox"/> Links	<input type="checkbox"/> Rechts	<input type="checkbox"/> Links	<input type="checkbox"/> Rechts	<input type="checkbox"/> Links	<input type="checkbox"/> Rechts	<input type="checkbox"/> Links	<input type="checkbox"/> Rechts
							
Trekrem (trekken om te remmen)		Drukrem (drukken om te remmen)		Lange drukrem, neerklapbaar (drukken om te remmen)		Éénhandrem (drukken om te remmen)	
Standaard		Standaard		€ 58	€ 58	€ 290	
Art : 800-47103	Art : 800-47203	Art : 800-47104	Art : 800-47204	Art : 800 - 07105	Art : 800 - 07205	Art : 800-47110	

Voorwiel (set)





Mogelijkheden i.v.m. zithoogtes zie technisch maatblad

<input type="checkbox"/>		<input type="checkbox"/>	
Soft 6" Kunststof		Super Soft 6" Kunststof met breed loopvlak	
€ 15		€ 296	
Art : 800 - 06001		Art : 800 - 06004	





<input type="checkbox"/>		<input type="checkbox"/>		<input type="checkbox"/>		<input type="checkbox"/>	
Soft 5" Kunststof		Hard 5" Kunststof		Hard 5" Aluminium		Super Soft 5" Kunststof met breed loopvlak	
Standaard		€ 25		€ 115		€ 260	
Art : 800 - 05001		Art : 800 - 05002		Art : 800 - 05003		Art : 800 - 05004	

<input type="checkbox"/>		<input type="checkbox"/>		<input type="checkbox"/>		<input type="checkbox"/>	
Soft 4" Kunststof		Hard 4" Kunststof		Hard 4" Aluminium		Super Soft 4" Kunststof met breed loopvlak	
€ 22		€ 25		€ 90		€ 260	
Art : 800 - 04001		Art : 800 - 04002		Art : 800 - 04003		Art : 800 - 04004	

Antikiep







<input type="checkbox"/> Links	<input type="checkbox"/> Rechts	<input type="checkbox"/> Links	<input type="checkbox"/> Rechts	<input type="checkbox"/> Links	<input type="checkbox"/> Rechts	<input type="checkbox"/> Links	<input type="checkbox"/> Rechts
							
Antikiep Telescopisch in hoogte verstelbaar		Antikiep - 360° draaibaar (éénzijdig te monteren)		Trappijp - vast (niet in combinatie met antikiep set)		Stokhouder	
€ 135	€ 135	€ 184	€ 184	€ 85	€ 85	€ 78	€ 78
Art : 800 - 44000	Art : 800 - 45000	Art : 800-44010	Art : 800-45010	Art : 800-43200	Art : 800-43700	Art : 800-43210	Art : 800-43710

Zijschild



<input type="checkbox"/>	<input type="checkbox"/>	<input type="checkbox"/>	<input type="checkbox"/>	<input type="checkbox"/>
				
Zijschild vast, kunststof, scharnierend Alleen leverbaar i.c.m. zitting cordura en ruoscharnier basis	Zijschild afneembaar zonder spatrand, alleen in combinatie met armleuning	Zijschild vast, zonder spatrand, aluminium	Zijschild vast met spatrand, aluminium	Zijschild vast met spatrand, carbon
€ 0,-	€ 96	€ 96	€ 210	€ 335
Art : 100 - 96070	Art : 100 - 96030	Art : 100 - 96040	Art : 100 - 96050	Art : 100 - 96010



Armsteunen

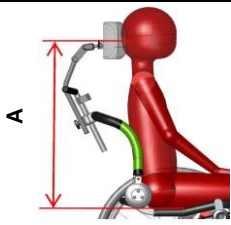

Armpolstering



<input type="checkbox"/>	<input type="checkbox"/>	<input type="checkbox"/>	<input type="checkbox"/>	<input type="checkbox"/>	<input type="checkbox"/>	<input type="checkbox"/>	<input type="checkbox"/>
		<input type="checkbox"/> Links 	<input type="checkbox"/> Rechts 	<input type="checkbox"/> Links 	<input type="checkbox"/> Rechts 	Maatwerk	
In hoogte verstelbare armsteun, afneembaar, vaste hoek met standaard polstering. Montage bij zijschild met spatrand worden de zijschilden aangepast (alléén carbon, meerprijs).	In hoogte verstelbare armsteun, afneembaar, hoekinstelbaar met standaard polstering. Voor montage bij zijschild met spatrand worden de zijschilden aangepast (alléén carbon, meerprijs).	Hemiplegie-armpolstering (Per stuk)		Armpolstering lang 36 x 5,5cm 10cm langer als standaard (Per stuk)		Armpolstering in opdracht na tekening (per stuk)	
€ 330	€ 420	€ 205	€ 205	€ 75	€ 75	Op aanvraag	Op aanvraag
Art : 100 - 96110	Art : 100 - 96170	Art : 100 - 96140	Art : 100 - 96240	Art : 100 - 96180	Art : 100 - 96280	Art : 100 - 96130	Art : 100 - 96230

Accessoires

<input type="checkbox"/>	<input type="checkbox"/>		<input type="checkbox"/> 1 Stuk 	<input type="checkbox"/> 2 Stuks 
Duwbeugel, in hoogte verstelbaar en afneembaar	Hoofdsteun, in hoogte verstelbaar en afneembaar (Maat A aangeven)		Optreksteun voor aan de rug <i>Los bijgeleverd</i>	
€ 225	€ 237		€ 98	€ 196
Art : 100 - 210 x x	Art : 100 - 230 x x	A (cm) =		Art : 100 - 47010 Art : 100 - 47020

<input type="checkbox"/>	<input type="checkbox"/>	<input type="checkbox"/>	<input type="checkbox"/>	<input type="checkbox"/>	<input type="checkbox"/>	<input type="checkbox"/>	<input type="checkbox"/>
		<input type="checkbox"/> 1 Stuk 	<input type="checkbox"/> 2 Stuks 	<input type="checkbox"/> 1 Stuk 	<input type="checkbox"/> 2 Stuks 		
Zijpelotte klein 10x12cm mogelijk vanaf rughoogte 45cm. <i>Los bijgeleverd</i>	Zijpelotte groot 14x14cm mogelijk vanaf rughoogte 45cm. <i>Los bijgeleverd</i>	Elastische ruggordel, verstelbaar met Seat-E-Lastica, 50mm breed <i>Los bijgeleverd</i>		Elastische ruggordel, verstelbaar met Seat-E-Lastica, 100mm breed <i>Los bijgeleverd</i>			
€ 288	€ 308	€ 65	€ 130	€ 65	€ 130		
Art : 800-01102 Art : 800-01202	Art : 800-01101 Art : 800-01201	Art : 100 - 46001	Art : 100 - 46002	Art : 100 - 46011	Art : 100 - 46012		

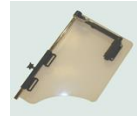
<input type="checkbox"/>	<input type="checkbox"/>
	
Incontinentie hoes	Extra zittinghoes
€ 110	€ 110
Art : 100 - 112 x x	Art : 100 - 111 x x

<input type="checkbox"/>	<input type="checkbox"/>	<input type="checkbox"/>	<input type="checkbox"/>
			
Kuitband	College-werkblad	Veiligheidsgordel	Tasje onder de zitting
€ 34	Op aanvraag	€ 92	€ 84
Art : 800 - 01001	Art : 800 - 01003	Art : 800 - 01002	Art : 800 - 01010

Het formulier s.v.p. volledig invullen en faxen naar. : +31 (0) 315 396 909 of mailen naar info@o4.eu

Onze algemene leverings- en verkoopvoorwaarden zijn te downloaden via www.o4.eu Technische wijzigingen en drukfouten voorbehouden.

Wheelchairs Markenweg 9, 7051 HS Varsseveld, Nederland T: +31 (0) 315 396 900 F: +31 (0) 315-396 909 E: info@o4.eu I: www.rolstoel.nl